



Heat Exchanger Replacement

This instructional manual is only intended for use by a qualified service professional or authorized Noritz Service Representative. Any unauthorized use of this manual may result in voiding the warranty.

Contact Noritz Technical Support (866-766-7489) for additional support.

Noritz America Corporation

11160 Grace Avenue, Fountain Valley, CA 92708







Phone 866-766-7489 Fax 714-241-1196

Procedure

1. Drain the unit as shown in following procedure.

[RC-9018M]

Drainage Using the Remote Controller

- 1** (1)  button is "OFF".
- (2) Press the  button inside the cover, Select **Misc settings** using the  buttons. Press the  button. The "Misc settings" screen appears.
- (3) Select **Drain water** using the  buttons, and then press  button.
- (4) Select "YES" using the  buttons,

No Drain water
 Yes now ?

 Press  button.

Follow the drain procedures in the manual

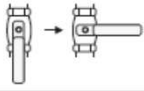
- 2** Close the water supply valve. 

- 3** Fully open all hot water fixtures/faucets. 

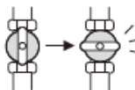

- 4** Open all drain plugs and drain the water out of the unit.

- 5** When the water is completely drained, replace all drain plugs and close the hot water fixtures/faucets.

- 6** Close the gas valve and disconnect the electrical power supplied to the unit. 

Do not touch with wet hands.

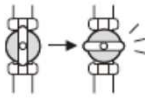
Manual Draining

- 1** Close the gas valve. 
- 2** (1) Turn the power on/off button "On".
 (2) Turn and leave open the hot water fixtures/faucets for more than 2 minutes and close. 
 * If multiple units are being used, drain two minutes for each unit.
 * An 11 Error Code may appear on the remote controller.
 This is not a malfunction of the unit.
 Do not turn Power ON/OFF Button OFF.

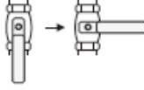
- 3** Close the water supply valve and disconnect the electrical power supplied to the unit. 

Do not touch with wet hands.

- 4** Fully open all hot water fixtures/faucets. 

- 5** Open all drain plugs and drain the water out of the unit.

- 6** When the water is completely drained, replace all drain plugs and close the hot water fixtures/faucets.

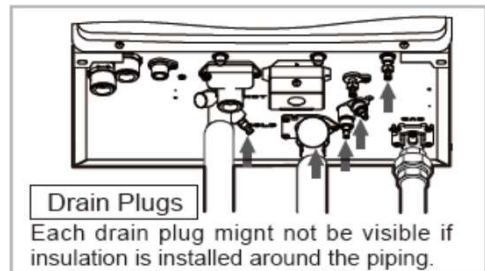

Heat Exchanger Replacement Procedure

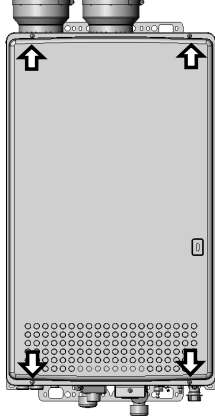
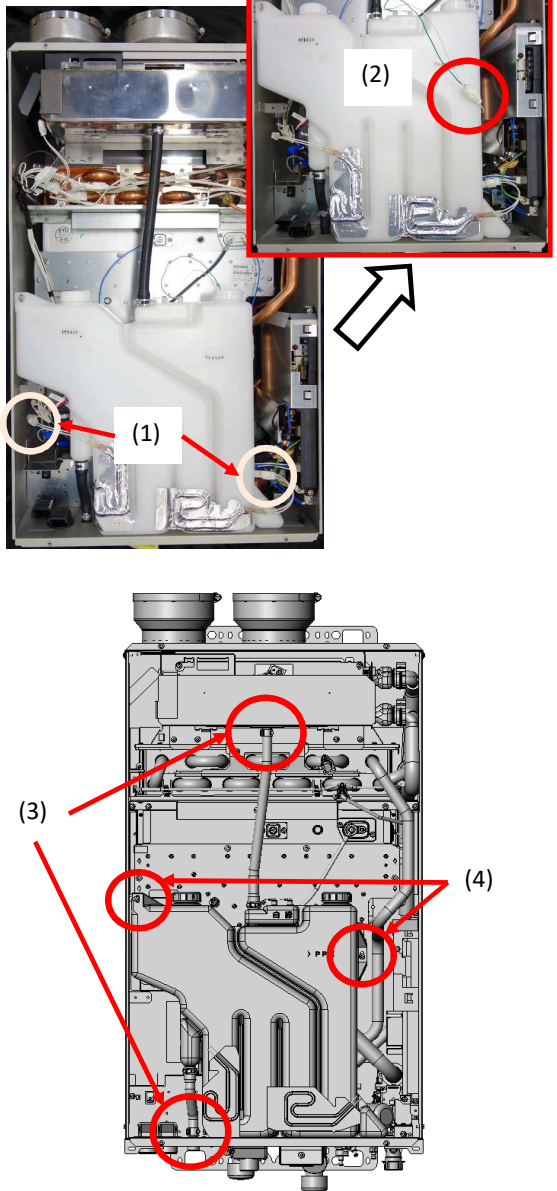
Procedure	Diagram
<p>2. Remove the Front Cover.</p> <p>(1) Remove 4 screws with washer(M4x12) and then remove the Front Cover.</p>	
<p>3. Remove the Condensate Container.</p> <p>(1) Disconnect 2 connectors of Freeze Prevention Heaters.</p> <p>(2) Disconnect the connector of the Water Level Electrode behind the Condensate Container.</p> <p>(3) Loosen the upper and the lower clamps and then disconnect each Drain Hose.</p> <p>(4) Remove 2 screws(M4x12) and then remove the Condensate Container.</p>	

Heat Exchanger Replacement Procedure

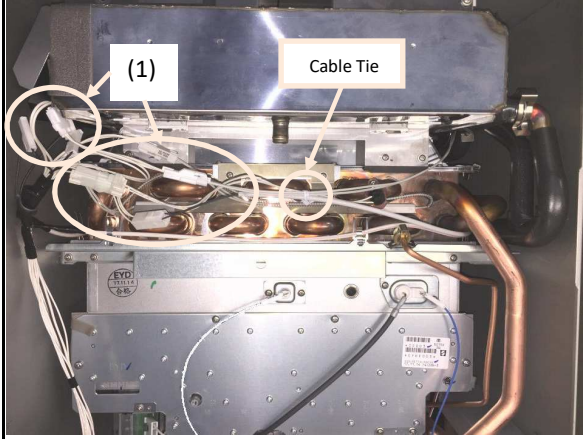
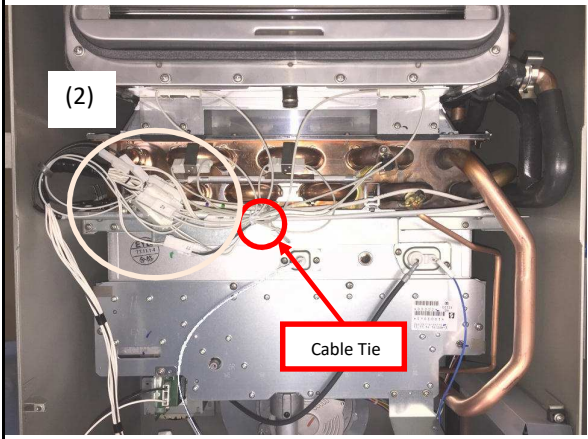
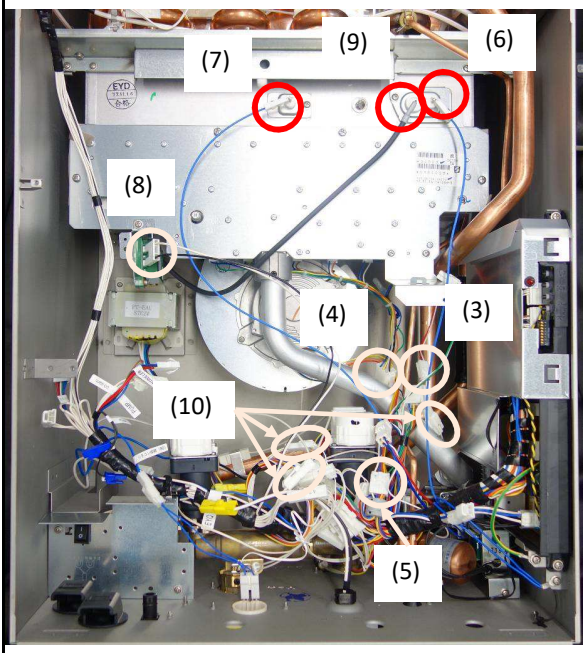
Procedure	Diagram
<p>4. Disconnect the specific Wiring Harness to remove the Heat Exchanger assembly from the Case.</p> <p>< DV model only ></p> <p>(1) Remove the Cable Tie and disconnect 3 connectors of Freeze Prevention Heaters. Disconnect 2 connectors of the Thermal Fuse. Disconnect the connector of the Thermistor-Exhaust. Disconnect the connector of the Hight Limit Switch. Disconnect the connector of the Thermistor-Scale Detection.</p> <p>< OD model only ></p> <p>(2) Remove the Cable Tie and disconnect 5 connectors of Freeze Prevention Heaters. Disconnect 2 connectors of the Thermal Fuse. Disconnect the connector of the Hight Limit Switch. Disconnect the connector of the Thermistor-Scale Detection.</p> <p>< DV ·OD model ></p> <p>(3) Disconnect the connector of the Thermistor-Burner.</p> <p>(4) Disconnect the connector of the Manifold Plate.</p> <p>(5) Disconnect the connector of the Fan Motor.</p> <p>(6) Disconnect the connector of the Flame Rod-1 with a blue wire.</p> <p>(7) Disconnect the connector of the Flame Rod-2 with a white wire.</p> <p>(8) Disconnect the connector of the Igniter.</p> <p>(9) Disconnect the connector of the Ignition Plug.</p> <p>(10) Disconnect 3 connectors of the Freeze Prevention Heater. (For Pipe-Water Inlet, Pipe-Water Outlet and Pipe-Drain)</p>	<p style="text-align: center;">< DV model ></p>  <p style="text-align: center;">< OD model ></p>  

Heat Exchanger Replacement Procedure

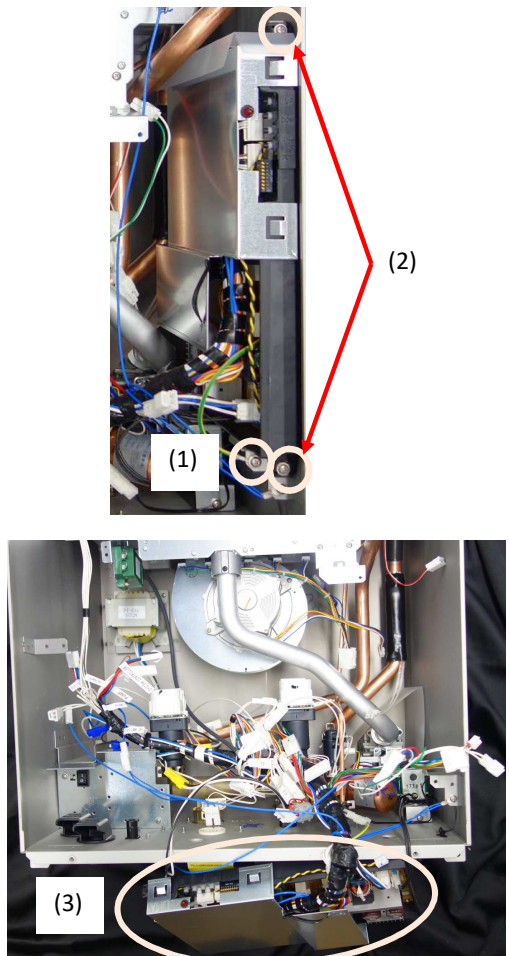
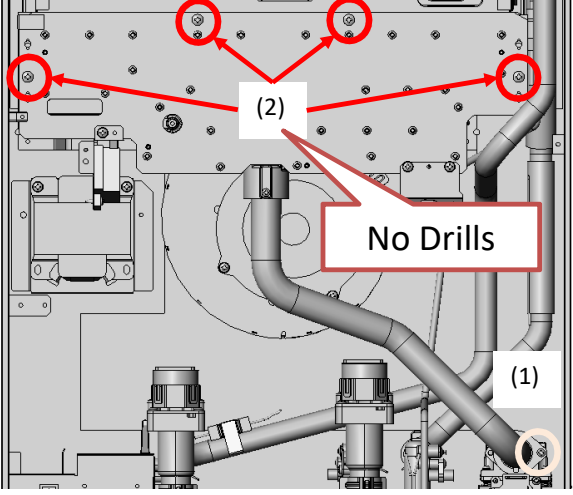
Procedure	Diagram
<p>5. Remove the Circuit Board.</p> <p>(1) Remove screw(M4 × 8).</p> <p>(2) Remove 2 screws(M4 × 12) that hold the Circuit Board.</p> <p>(3) Take out the Circuit Board from the unit.</p>	 <p>The diagram for step 5 consists of two photographs. The top photograph shows a close-up of the circuit board mounted on the unit. A red arrow points to a screw labeled (1) at the top. Two other screws are circled in white and labeled (2) at the bottom. The bottom photograph shows the circuit board being removed from the unit, with a white oval highlighting the board and labeled (3).</p>
<p>6. Remove the Manifold Plate and the Gas Pipe SET.</p> <p>(1) Remove screw-black(M4 × 8).</p> <p>(2) Remove 4 screws(M5 × 16) and then remove the Manifold Plate and the Gas Pipe SET.</p> <p>* In this instance, only loosen by a hand screwdriver. (No Drills)</p>	 <p>The diagram for step 6 is a technical drawing of the manifold plate and gas pipe set. It shows four screws circled in red and labeled (2) with red arrows. One screw is circled in white and labeled (1) at the bottom right. A callout box with a red border contains the text 'No Drills'.</p>

Heat Exchanger Replacement Procedure

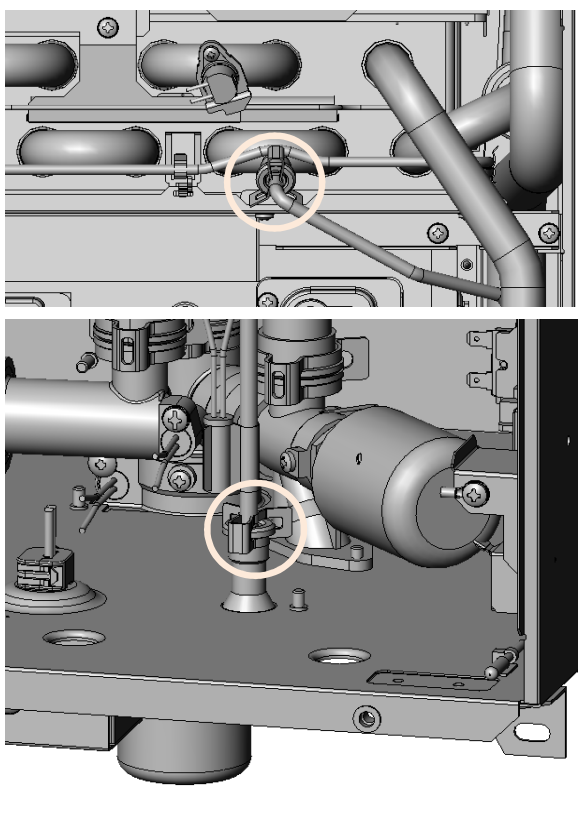
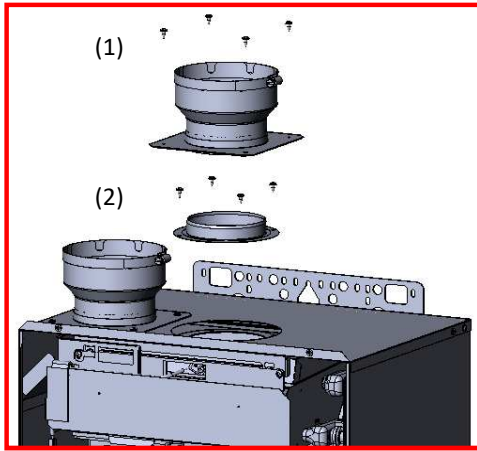
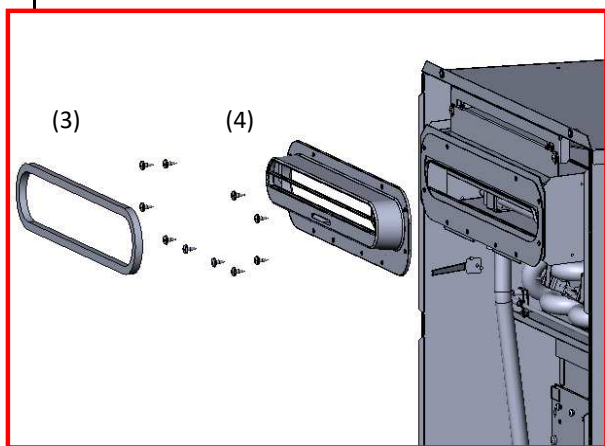
Procedure	Diagram
<p>7. Remove the Pipe-1/4 inch Drain from Heat Exchanger.</p> <p>(1) Remove the upper and the lower "C" Clamps.</p> <p>(2) Remove the upper side of the Pipe-1/4 inch Drain first, and then the lower side.</p>	
<p>8. Remove the Exhaust parts.</p> <p>< DV model only ></p> <p>(1) Remove 4 screws(M4x10) and then remove the Exhaust Flue Adapter.</p> <p>(2) Remove 4 screws(M4x10) and then remove the Exhaust Flue Damper.</p> <p>< OD model only ></p> <p>(3) Remove the Gasket-Front Top. * As this gasket is reused, do not damage it.</p> <p>(4) Remove 10 screws(M4 × 10) and then remove the Exhaust Top.</p>	<p style="text-align: center;">< DV model ></p>  <p style="text-align: center;">< OD model ></p> 

Heat Exchanger Replacement Procedure

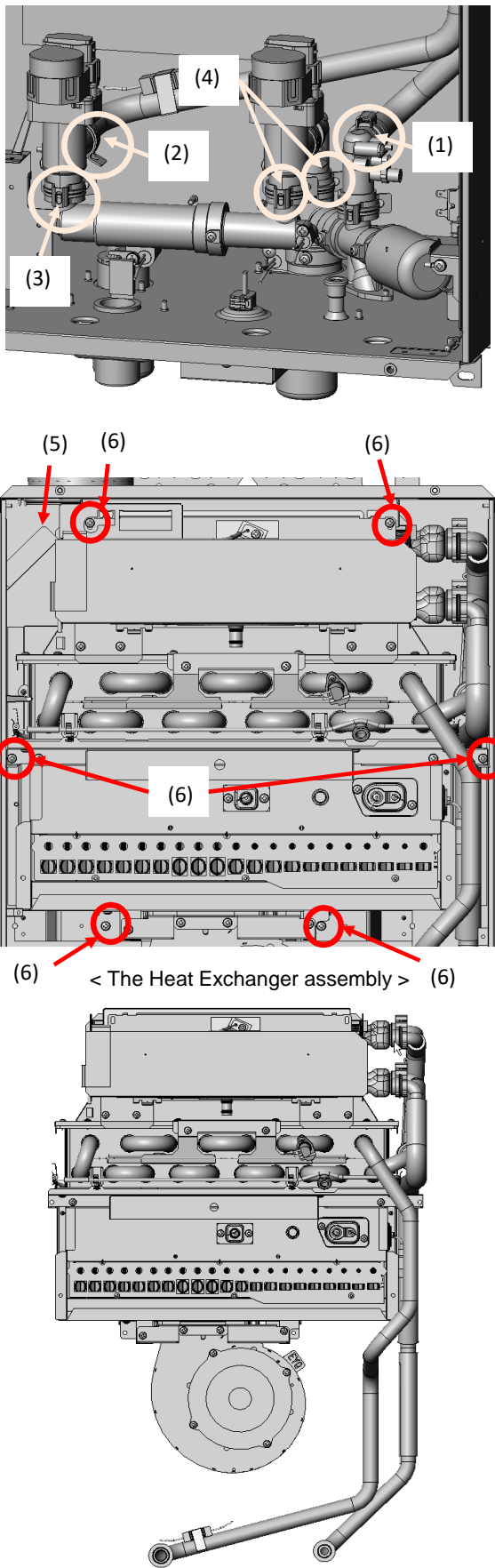
Procedure	Diagram
<p>9. Remove the Heat Exchanger assembly from the Case.</p> <p>(1) Remove the "C" Clamp and then remove the Pipe-Water Inlet.</p> <p>(2) Remove the "C" Clamp and then remove the Pipe-Water Outlet.</p> <p>(3) Remove the "C" Clamp and then remove the Water Servo-Main.</p> <p>(4) Remove 2 "C" Clamps and then remove the Water Servo-Bypass and the Water Flow Sensor.</p> <p>(5) Remove the Cover Freeze prevention.</p> <p>(6) Remove 6 screws(M4×8) and then remove the Heat Exchanger assembly from the Case.</p>	 <p>(5) (6) (6)</p> <p>(6)</p> <p>(6) < The Heat Exchanger assembly > (6)</p>

Heat Exchanger Replacement Procedure

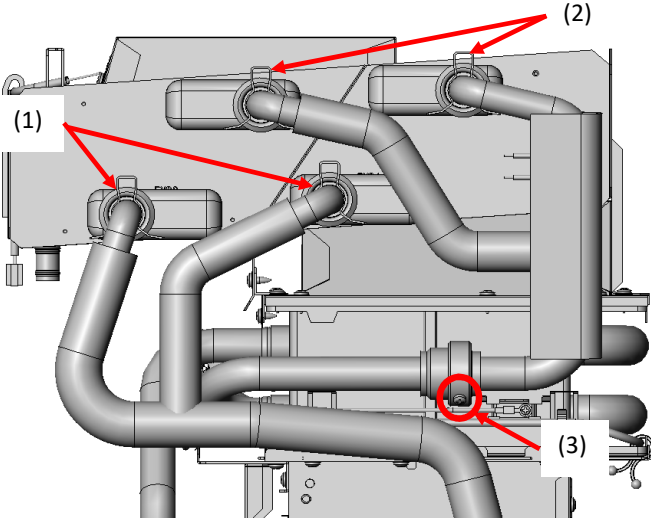
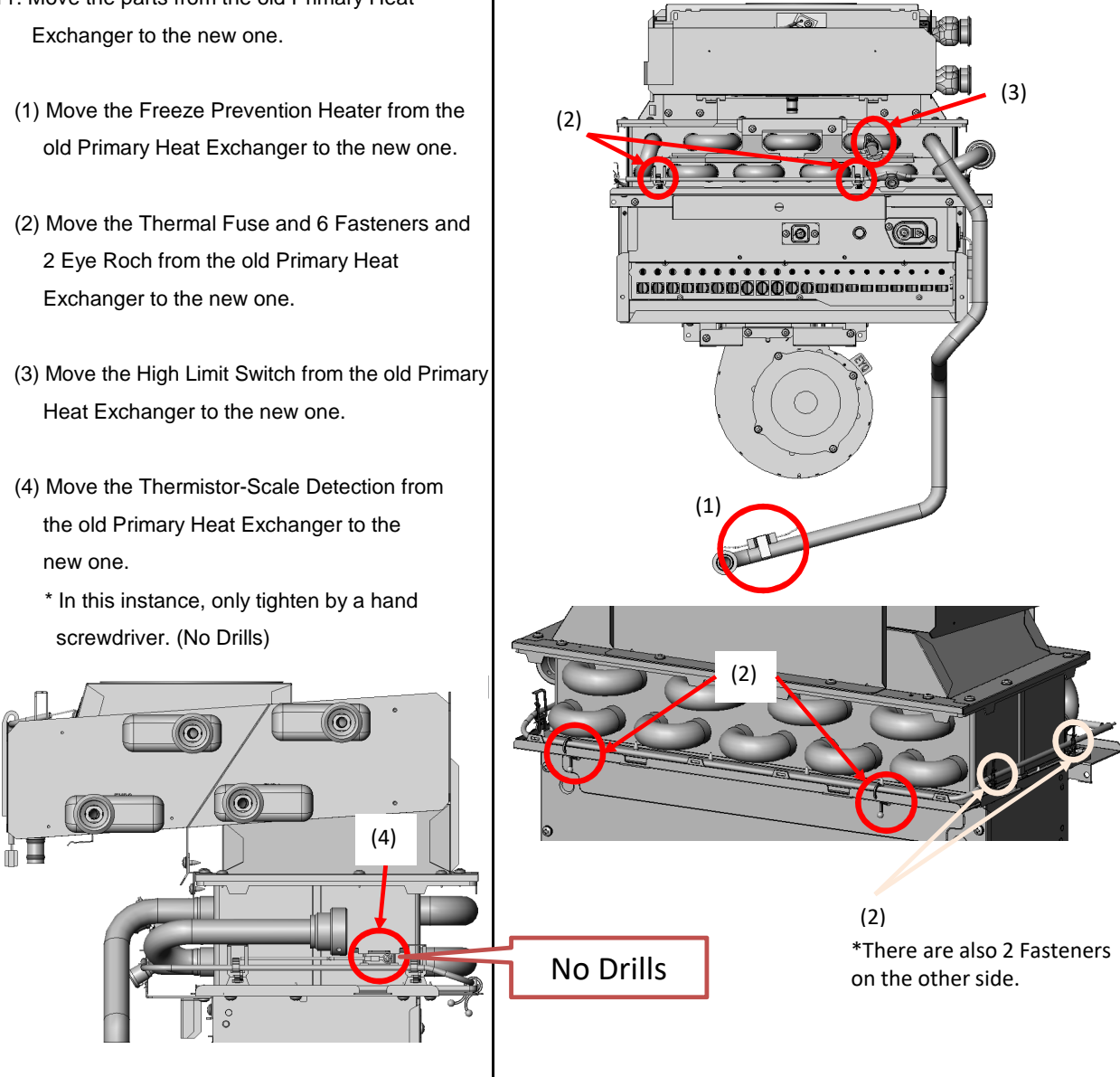
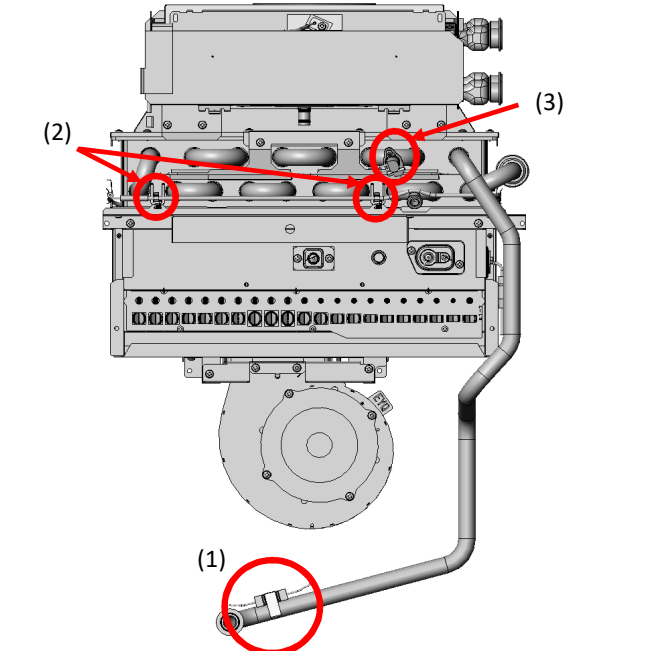
Procedure	Diagram
<p>10. Remove the Pipe-Water Inlet and the Pipe-Secondary Heat Exchanger.</p> <p>(1) Remove 2 "C" Clamps and then remove the Pipe-Water Inlet.</p> <p>(2) Remove 2 "C" Clamps.</p> <p>(3) Remove screw-black(M4 × 8) and then remove the Pipe-Secondary Heat Exchanger.</p>	
<p>11. Move the parts from the old Primary Heat Exchanger to the new one.</p> <p>(1) Move the Freeze Prevention Heater from the old Primary Heat Exchanger to the new one.</p> <p>(2) Move the Thermal Fuse and 6 Fasteners and 2 Eye Roch from the old Primary Heat Exchanger to the new one.</p> <p>(3) Move the High Limit Switch from the old Primary Heat Exchanger to the new one.</p> <p>(4) Move the Thermistor-Scale Detection from the old Primary Heat Exchanger to the new one.</p> <p>* In this instance, only tighten by a hand screwdriver. (No Drills)</p> 	 <p>(2)</p> <p>*There are also 2 Fasteners on the other side.</p>

Heat Exchanger Replacement Procedure

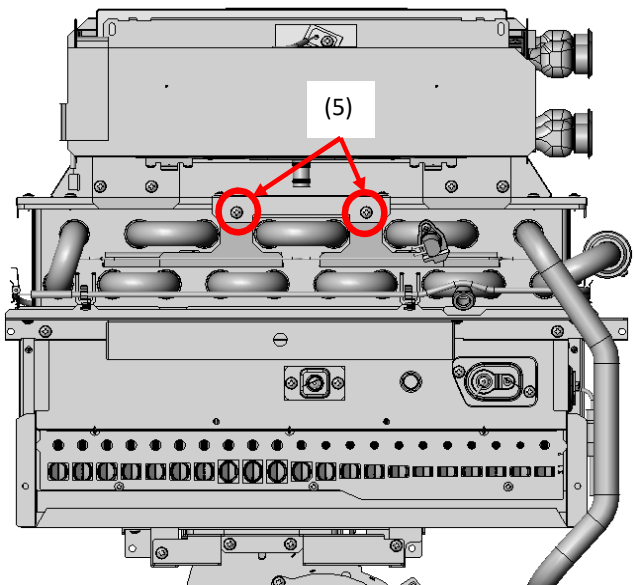
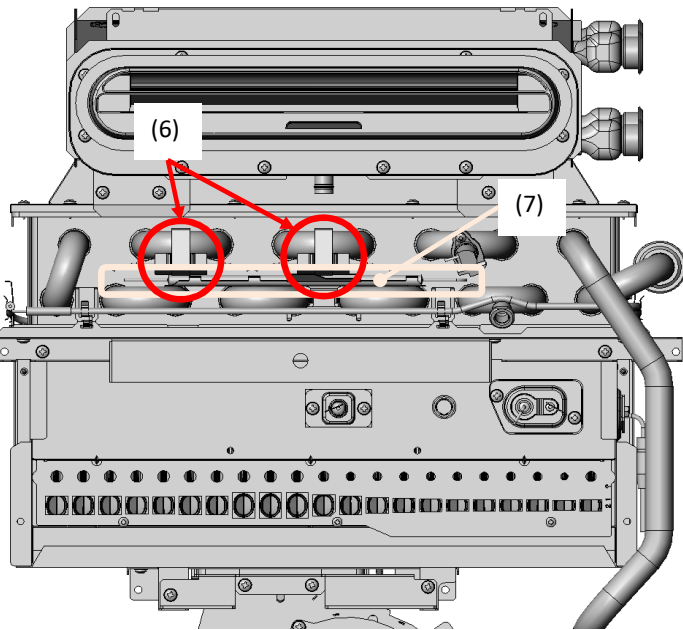
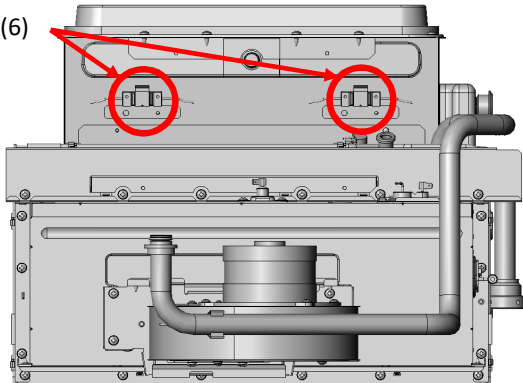
Procedure	Diagram
<p>< DV model only ></p> <p>(5) Remove 2 screws and move the Freeze Prevention Heater-Double Round from the old Primary HeatExchanger to the new one.</p> <p>< OD model only ></p> <p>(6) Move 4 Freeze Prevention Heater from the old Primary Heat Exchanger to the new one.</p> <p>(7) Move the Freeze Prevention Heater-Double Round from the old Primary Heat Exchanger to the new one.</p>	<p style="text-align: center;">< DV model ></p>  <p style="text-align: center;">< OD model ></p>  <p style="text-align: center;">< View from below of OD model ></p> 

Heat Exchanger Replacement Procedure

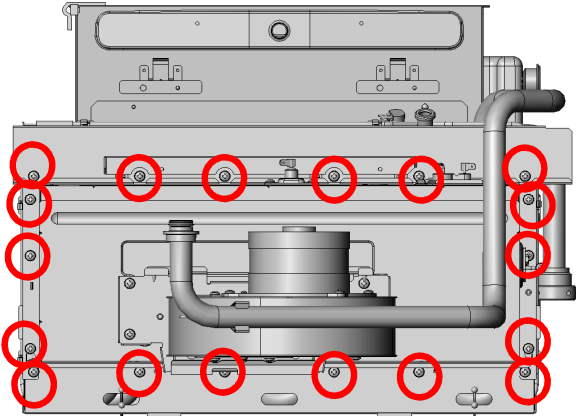
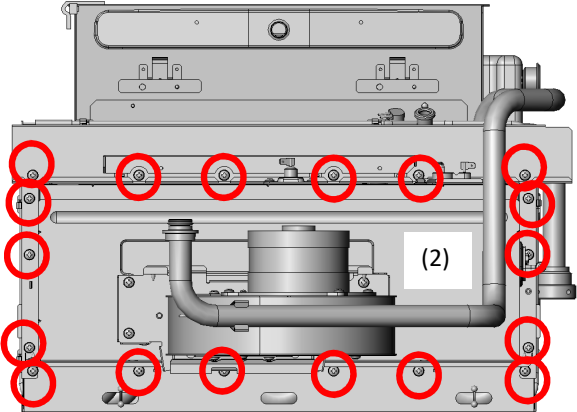
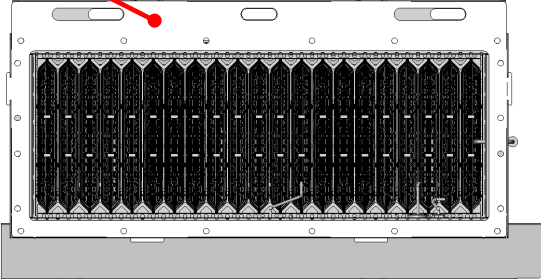
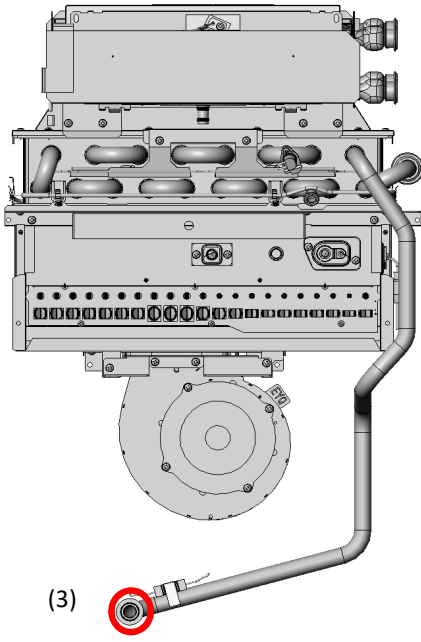
Procedure	Diagram
<p>12. Remove the Burner SET.</p> <p>(1) Remove 18 screws(M4 × 10) and then remove the Burner SET.</p>	
<p>13. Replace the Heat Exchanger.</p> <p>(1) Remove the old Gasket-Burner and replace with the new one.</p> <p>(2) Fix the Primary Heat Exchanger and Burner SET with 18 screws(M4x10).</p> <p>(3) Remove the old O-Ring and replace with the new one.</p> 	<p>< View of the Burner SET from above ></p> <p>(1) ↓ Back ↓</p>  <p>↑ Front ↑</p> 

Heat Exchanger Replacement Procedure

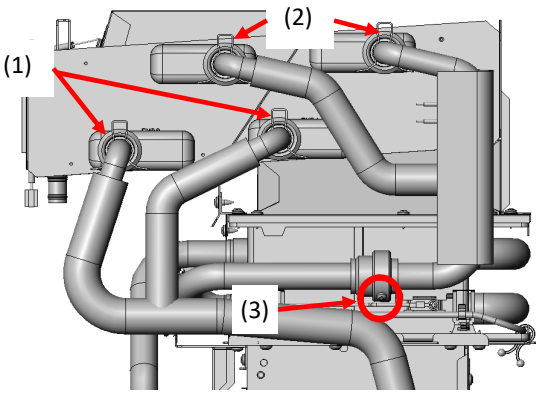
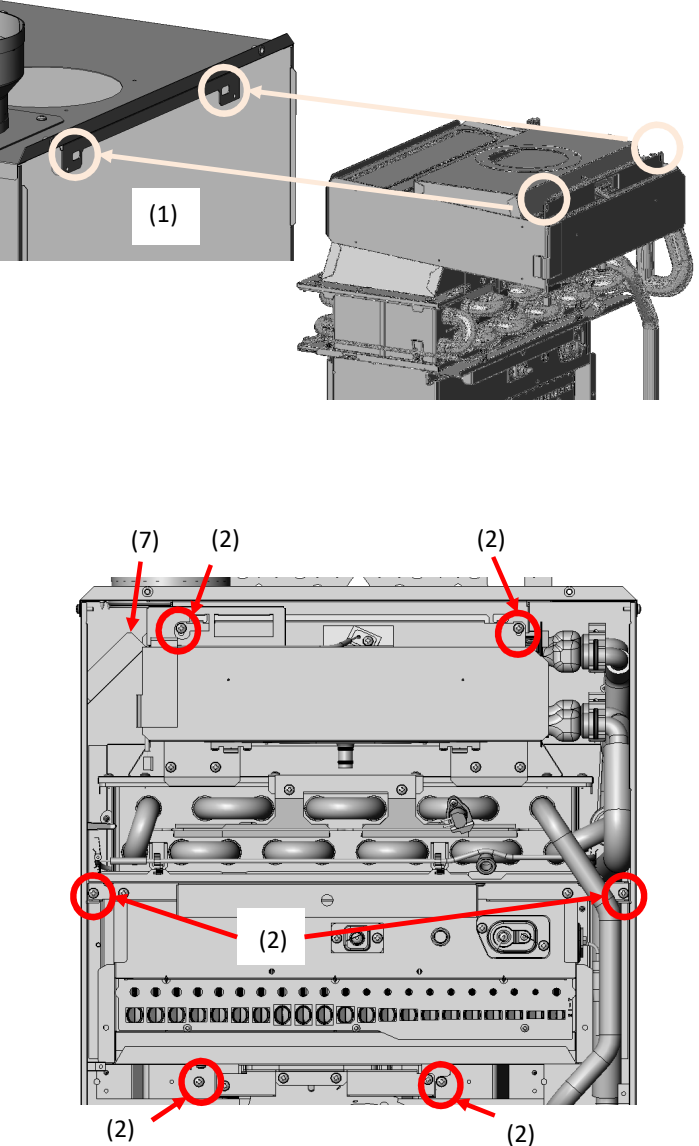
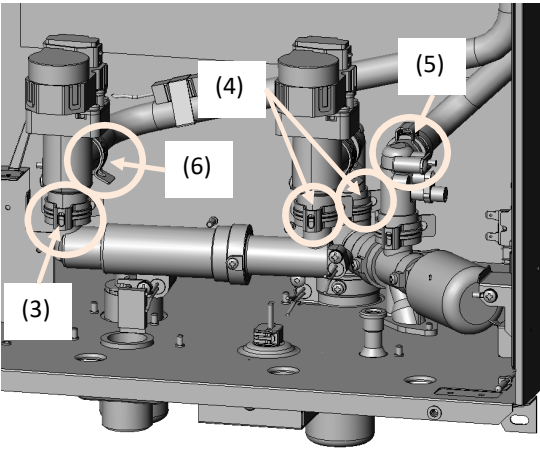
Procedure	Diagram
<p>14. Install the Pipe-Water Inlet and the Pipe-Secondary Heat Exchanger.</p> <p>(1) Install the Pipe-Water Inlet and fix with 2 "C" Clamps.</p> <p>(2) Install the Pipe-Secondary Heat Exchanger and then fix with 2 "C" Clamps.</p> <p>(3) Fix with screw-black(M4x8)</p>	
<p>15. Install the Heat Exchanger assembly to the Case.</p> <p>(1) Install the Heat Exchanger assembly by hooking on the hole located at the top of the Case.</p> <p>(2) Fix the Heat Exchanger assembly and the Case with 6 screws(M4x8).</p> <p>(3) Install the Water Servo-Main and fix with the "C" Clamp.</p> <p>(4) Install the Water Servo-Bypass and the Water Flow Sensor then fix with 2 "C" Clamps.</p> <p>(5) Install the Pipe-Water Inlet and fix with the "C" Clamp.</p> <p>(6) Install the Pipe-Water Outlet and fix with the "C" Clamp.</p> <p>(7) Install the Cover Freeze prevention.</p>	
	

Heat Exchanger Replacement Procedure

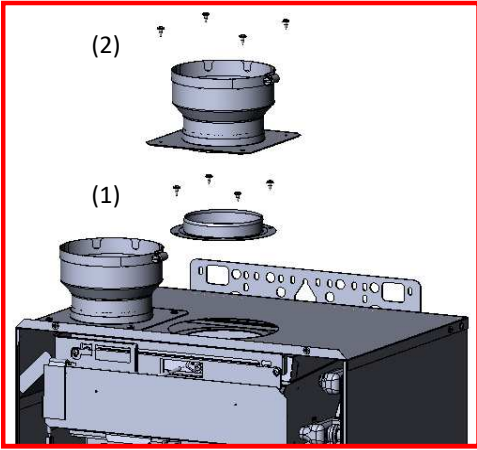
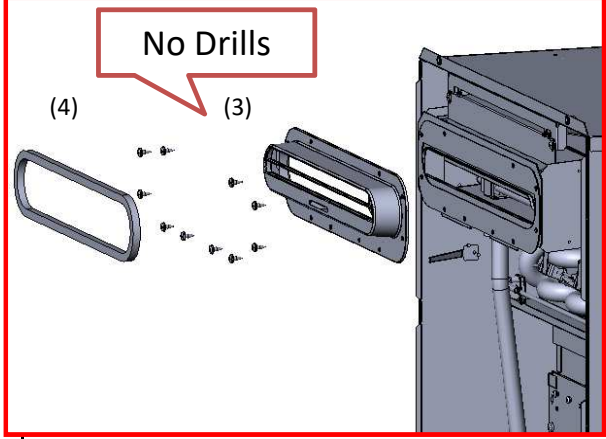
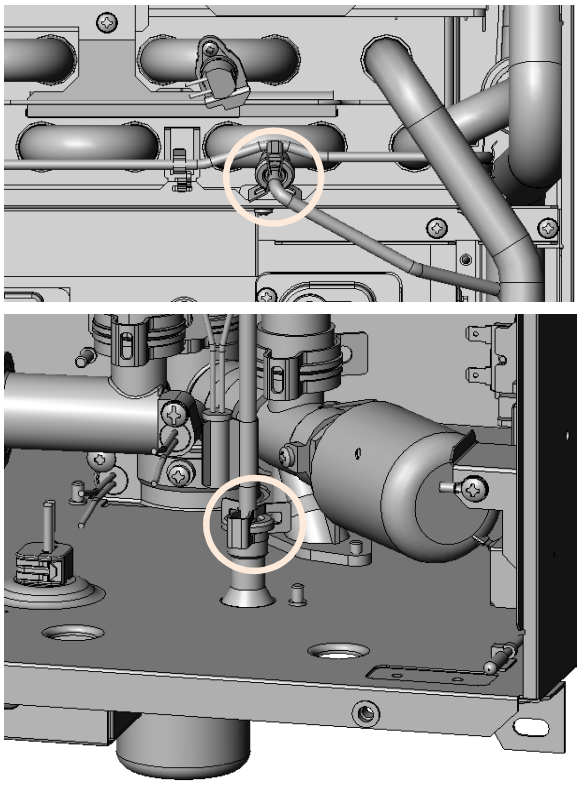
Procedure	Diagram
<p>16. Install the Exhaust parts.</p> <p>< DV model only ></p> <p>(1) Install the Exhaust Flue Damper and then fix with 4 screws(M4x10).</p> <p>(2) Install the Exhaust Flue Adapter and then fix with 4 screws(M4x10).</p> <p>< OD model only ></p> <p>(3) Install the Exhaust Top and then fix with 10 screws(M4x10).</p> <p>* In this instance, only tighten by a hand screwdriver. (No Drills)</p> <p>(4) Install the Gasket-Front Top.</p>	<p style="text-align: center;">Diagram</p> <p style="text-align: center;">< DV model ></p>  <p style="text-align: center;">< OD model ></p> 
<p>17. Install the Pipe-1/4 inch Drain from Heat Exchanger.</p> <p>(1) Install the lower side of the Pipe-1/4 inch Drain first, and then the upper side.</p> <p>(2) Install "C" Clamp to the upper and the lower side of the Pipe.</p>	

Heat Exchanger Replacement Procedure

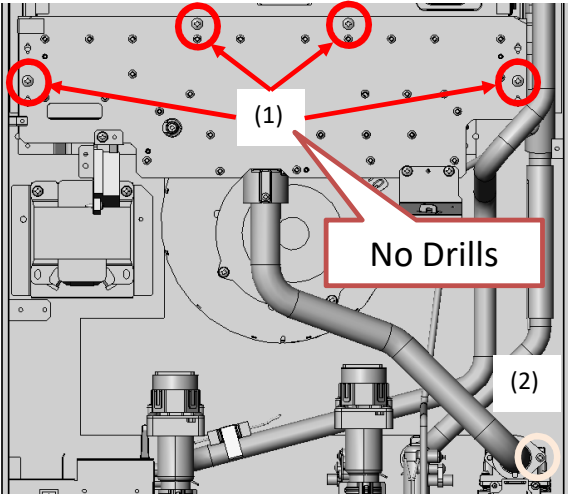
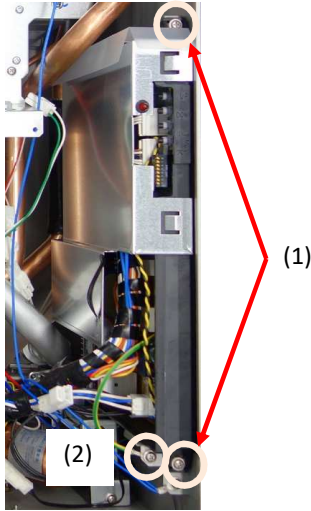
Procedure	Diagram
<p>18. Install the Manifold Plate and the Gas Pipe SET.</p> <p>(1) Install the Manifold Plate and the Gas Pipe SET and then fix with 4 screws(M5×16). * In this instance, only tighten by a hand screwdriver. (No Drills)</p> <p>(2) Install screw-black(M4 × 8).</p>	
<p>19. Install the Circuit Board.</p> <p>(1) Install the Circuit Board and then fix with 2 screws(M4 × 12).</p> <p>(2) Attach the ground wire with screw(M4 × 8).</p>	

Heat Exchanger Replacement Procedure

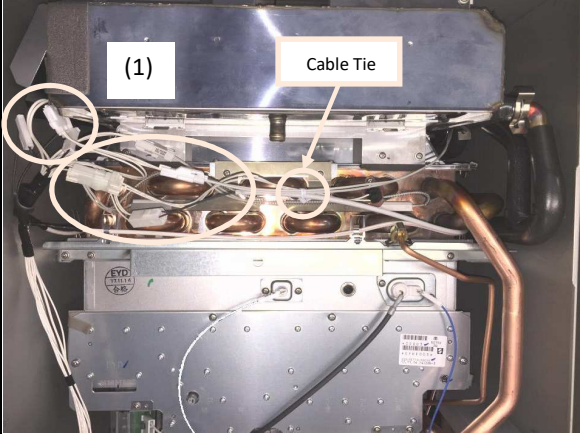
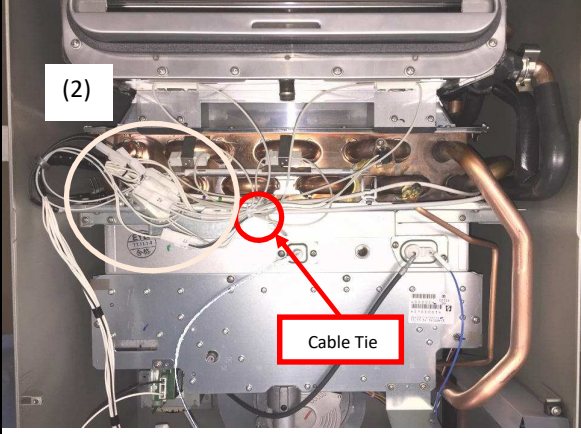
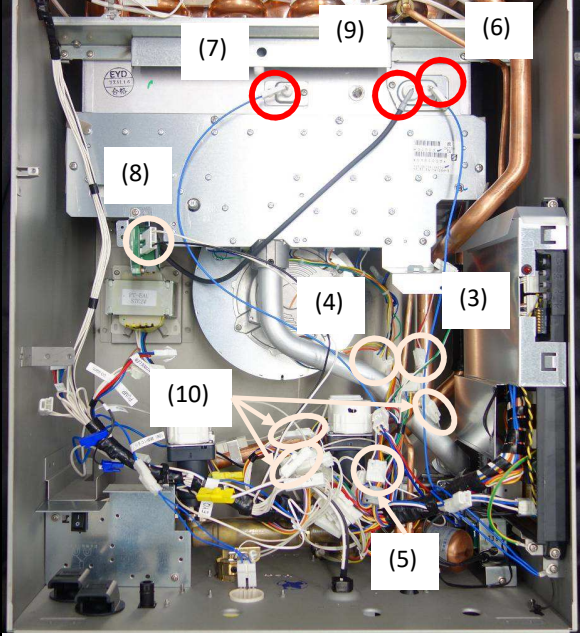
Procedure	Diagram
<p>20. Connect all wires that attach to Wiring Harness.</p> <p>< DV model only ></p> <p>(1) Connect 3 connectors of the Freeze Prevention Heaters. Connect 2 connectors of the Thermal Fuse. Connect the connector of the Thermistor-Exhaust. Connect the connector of the Hight Limit Switch. Connect the connector of the Thermistor-Scale Detection. Tie wires of "Freeze Prevention Heater for Pipe-Secondary Heat Exchanger", "Hight Limit Switch" and "Thermistor -Scale Detection" with a Cable Tie.</p> <p>< OD model only ></p> <p>(2) Connect 5 connectors of the Freeze Prevention Heaters. Connect 2 connectors of the Thermal Fuse. Connect the connector of the Hight Limit Switch. Connect the connector of the Thermistor-Scale Detection. Tie wires of "four Freeze Prevention Heater-Rectangle", "Hight Limit Switch" and "Thermistor-Scale Detection" with a Cable Tie.</p> <p>< DV ·OD model ></p> <p>(3) Connect the connector of the Thermistor-Burner.</p> <p>(4) Connect the connector of the Manifold Plate.</p> <p>(5) Connect the connector of the Fan Motor. * In this instance, route the Wiring Harness so that it passes above the Gas Pipe.</p> <p>(6) Connect the connector of Flame Rod-1 with a blue wire.</p> <p>(7) Connect the connector of Flame Rod-2 with a white wire.</p> <p>(8) Connect the connector of the Igniter.</p> <p>(9) Connect the connector of the Ignition Plug.</p> <p>(10) Connect 3 connectors of the Freeze Prevention Heater. (For Pipe-Water Inlet, Pipe-Water Outlet and Pipe-Drain)</p>	<p style="text-align: center;">< DV model ></p>  <p style="text-align: center;">< OD model ></p>  

Heat Exchanger Replacement Procedure

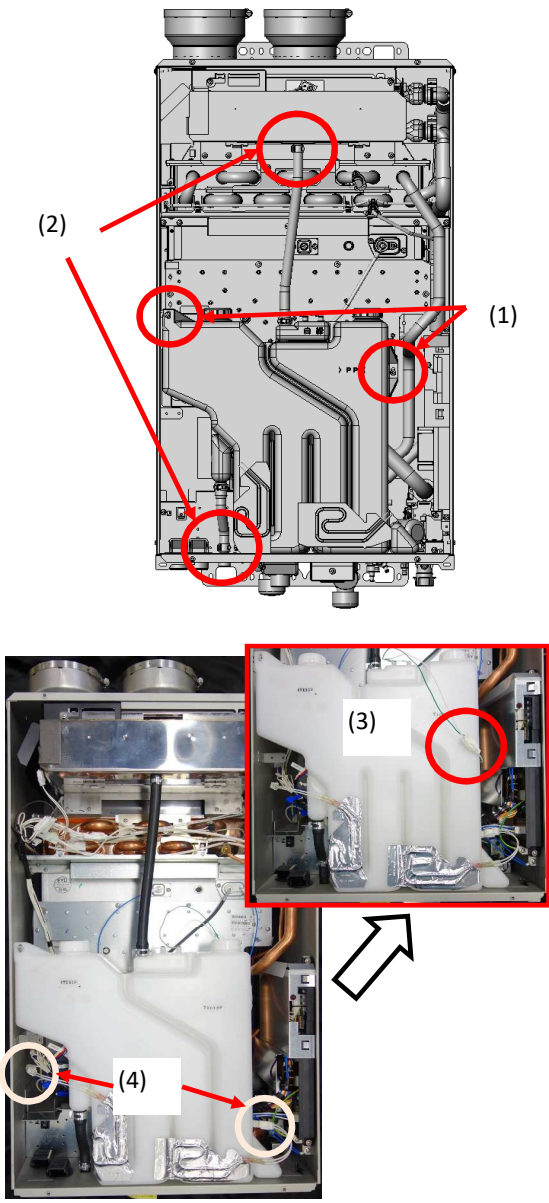
Procedure	Diagram
<p>21. Install the Condensate Container.</p> <p>(1) Install the Condensate Container by fixing with 2 screws(M4x12).</p> <p>(2) Connect the upper and the lower Drain Hoses and then secure each Drain Hose with the clamp.</p> <p>(3) Connect the Water Level Electrode behind the Condensate Container.</p> <p>(4) Connect 2 connectors of the Freeze Prevention Heaters.</p>	
<p>22. Install the Front Cover.</p> <p>(1) Install the Front Cover by fixing with 4 screws with washer(M4x12).</p>	